

SINALIZAÇÃO HORIZONTAL

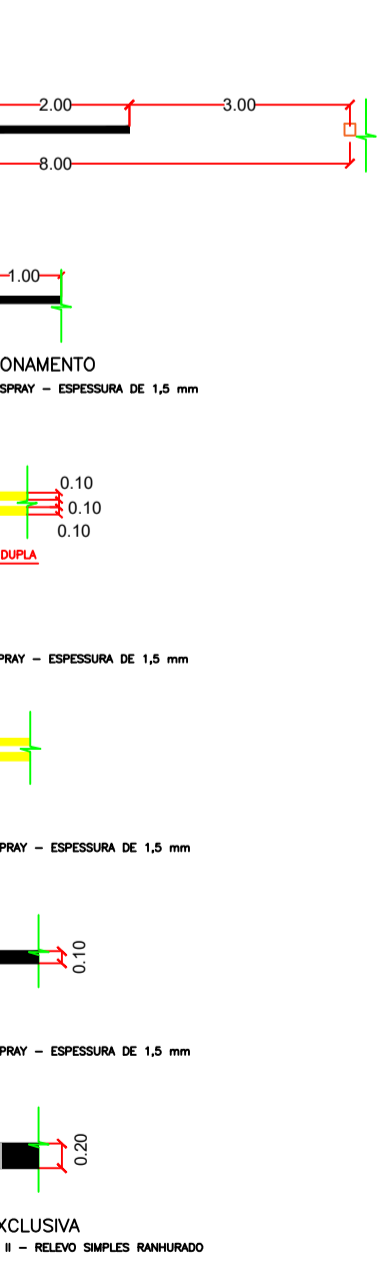
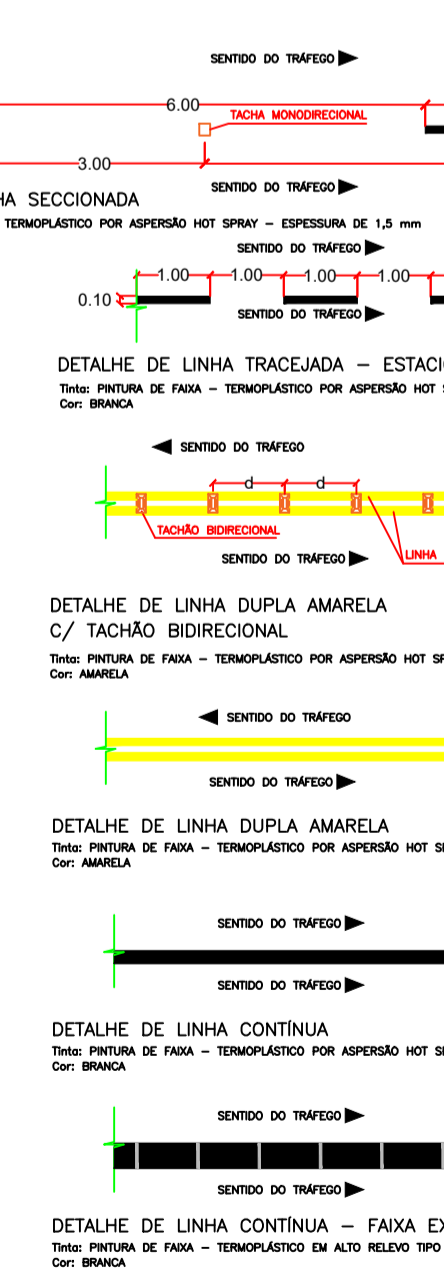
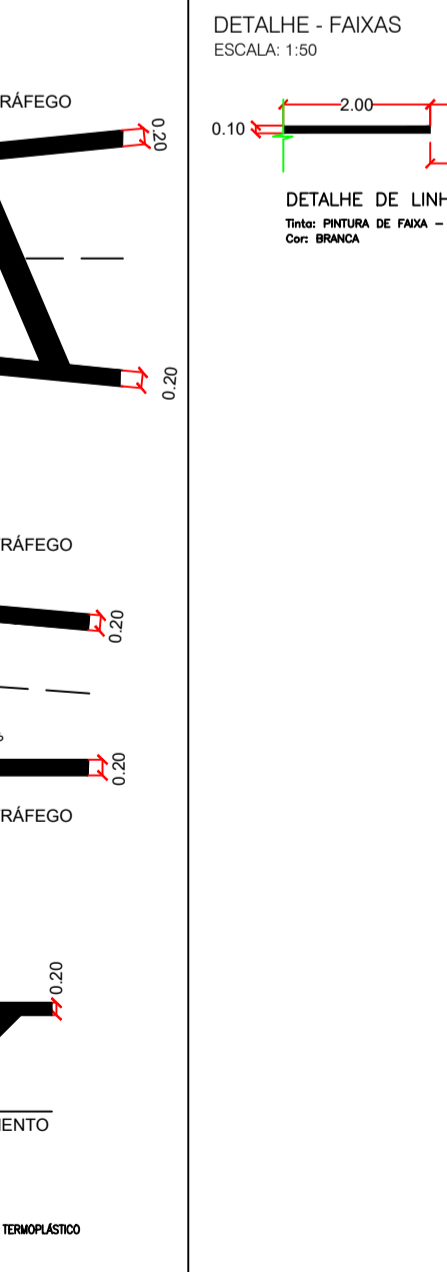
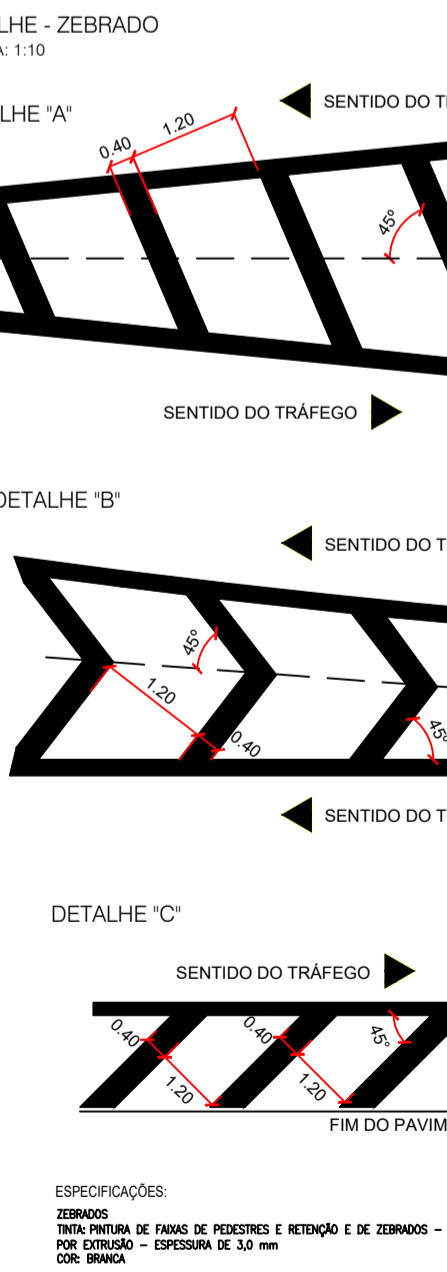
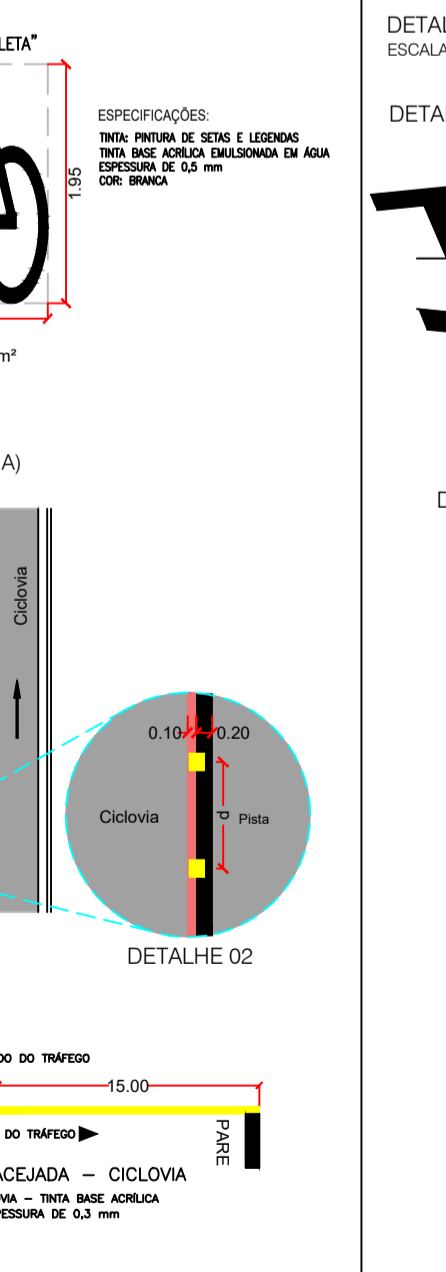
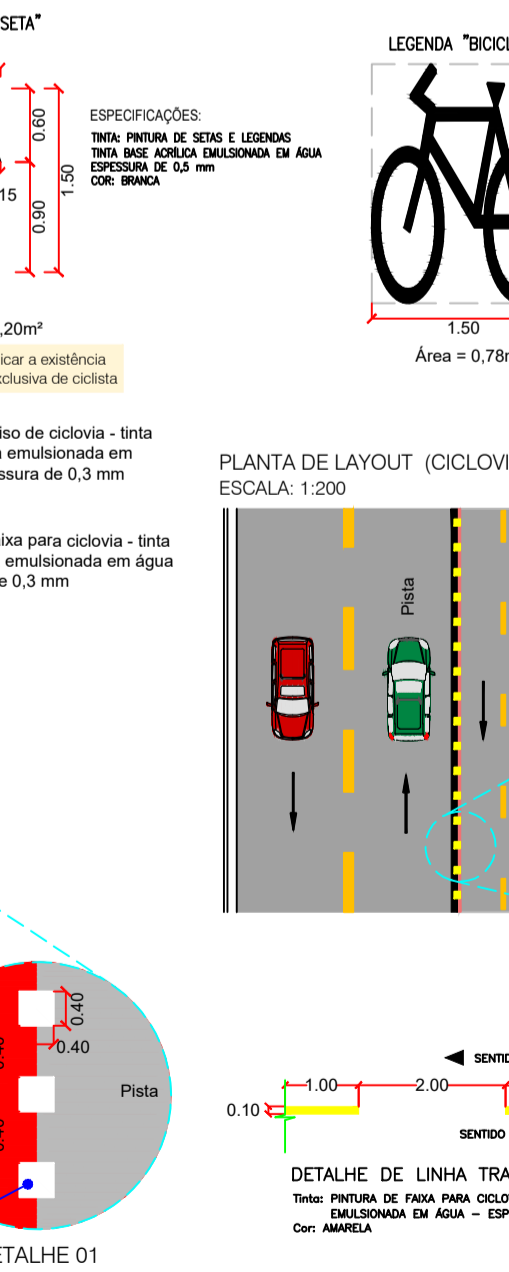
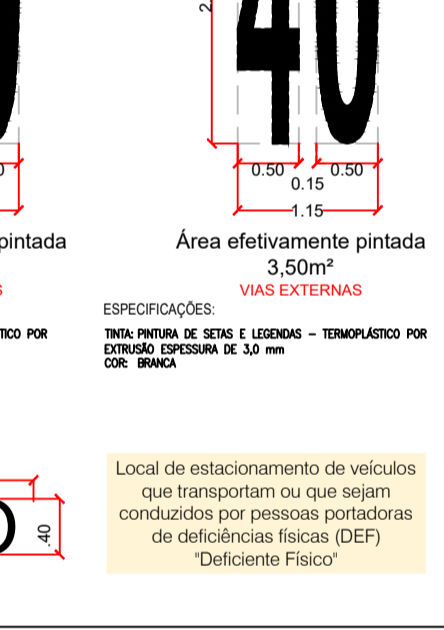
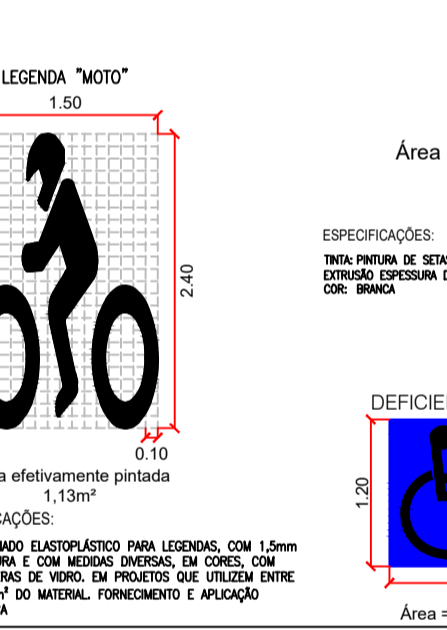
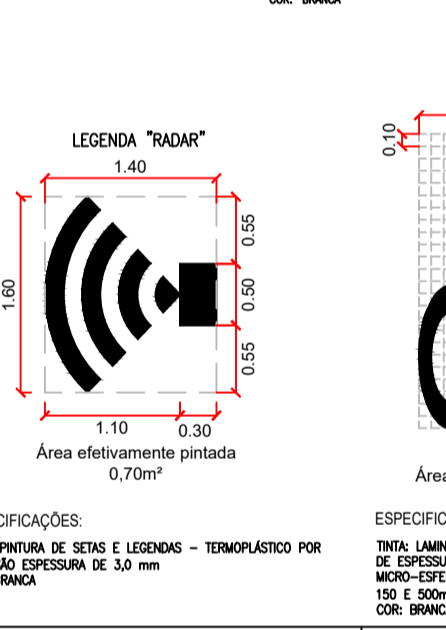
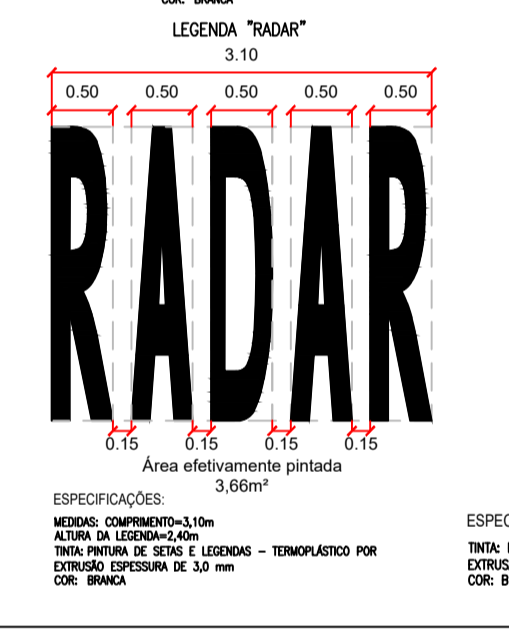
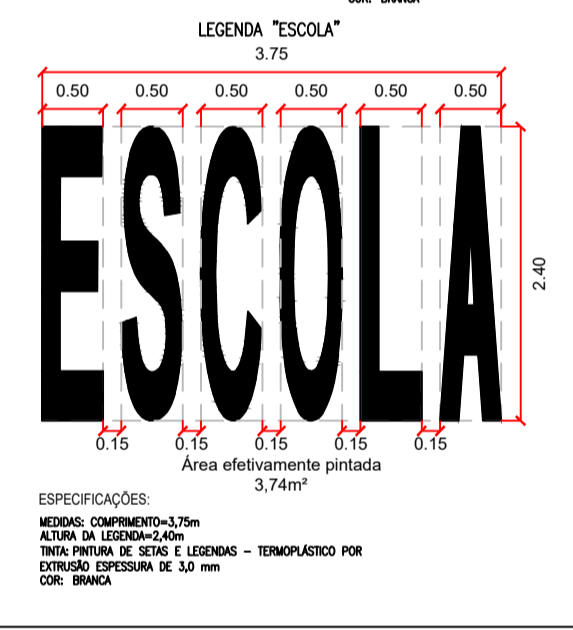
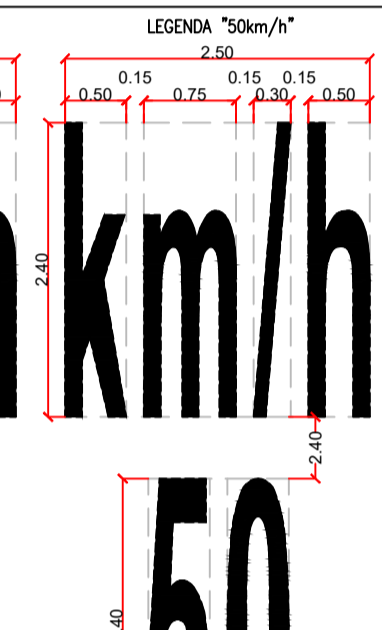
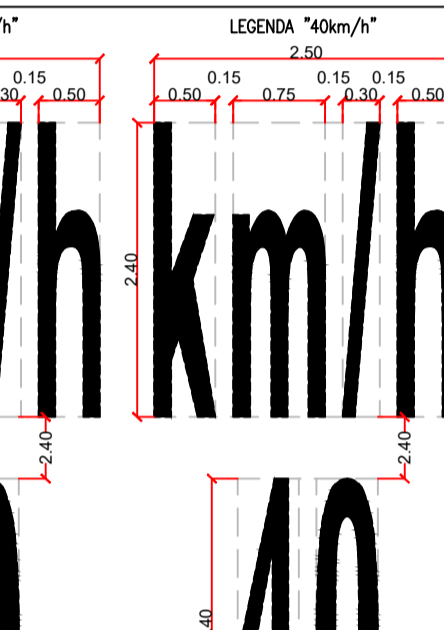
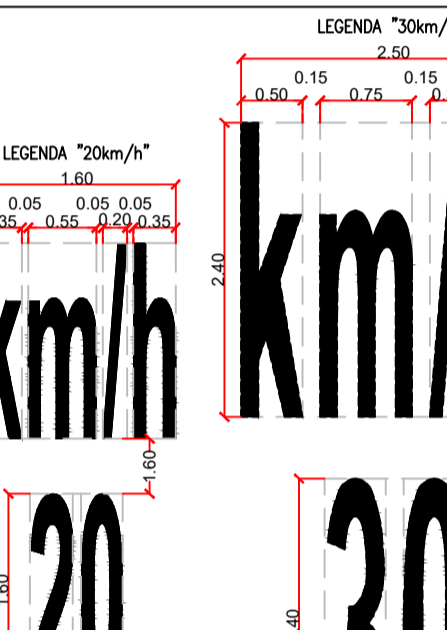
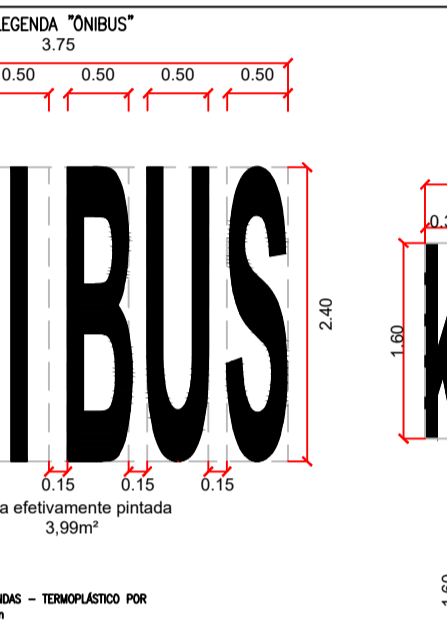
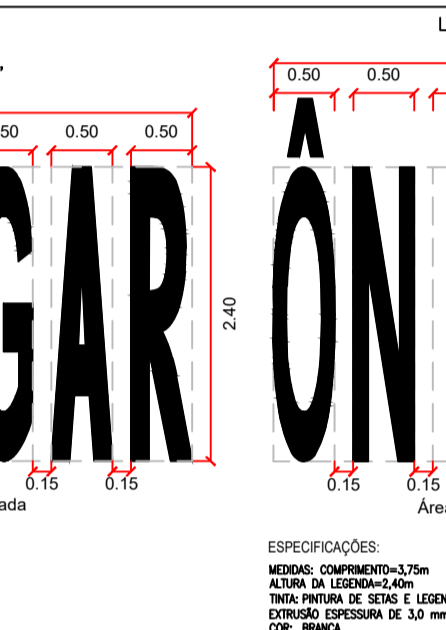
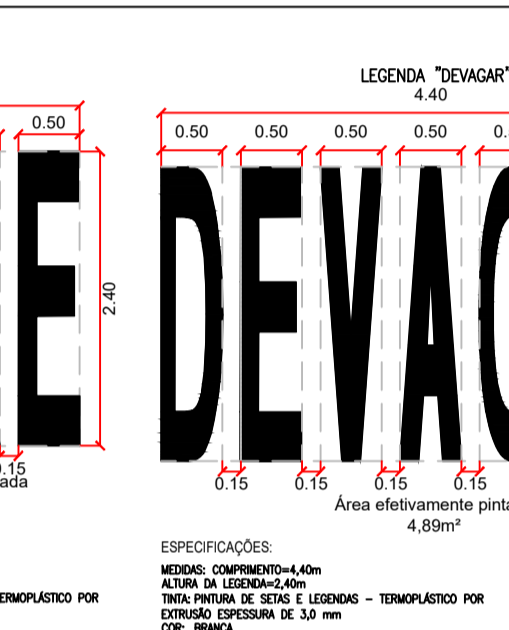
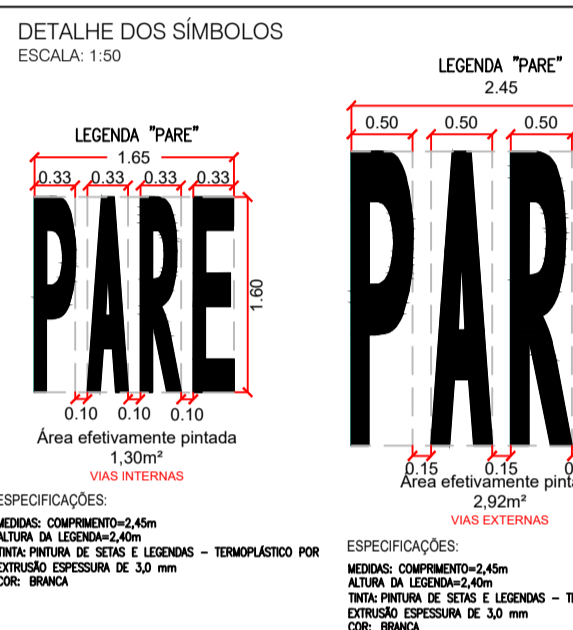
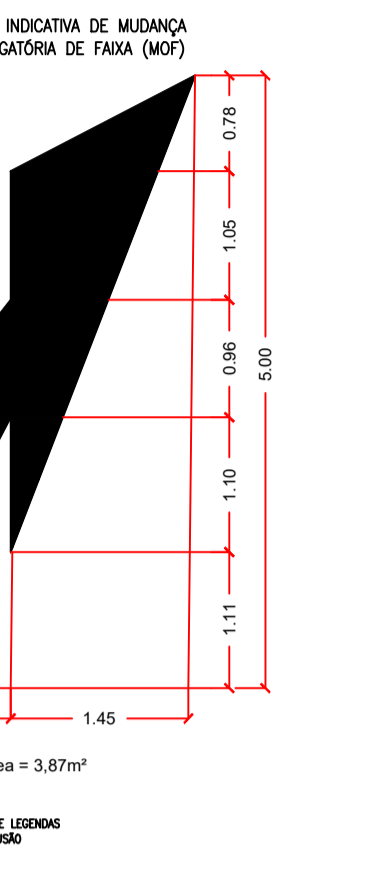
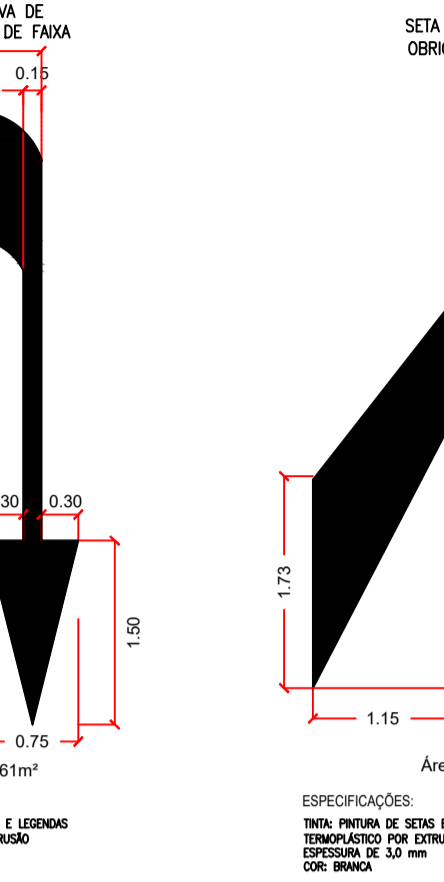
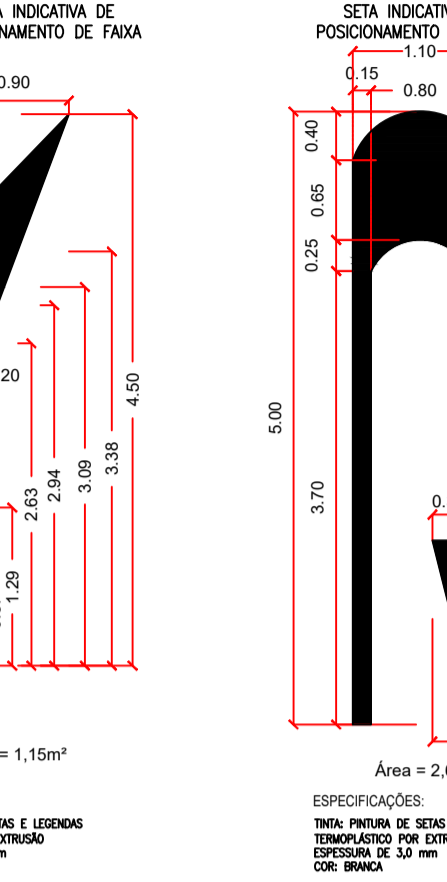
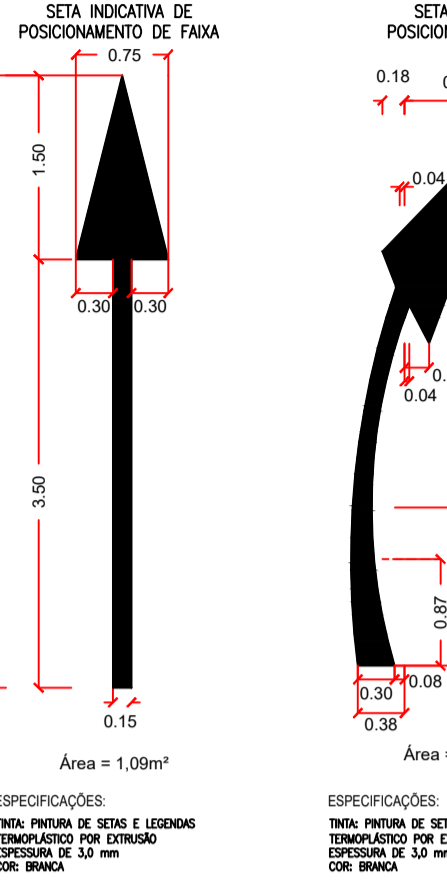
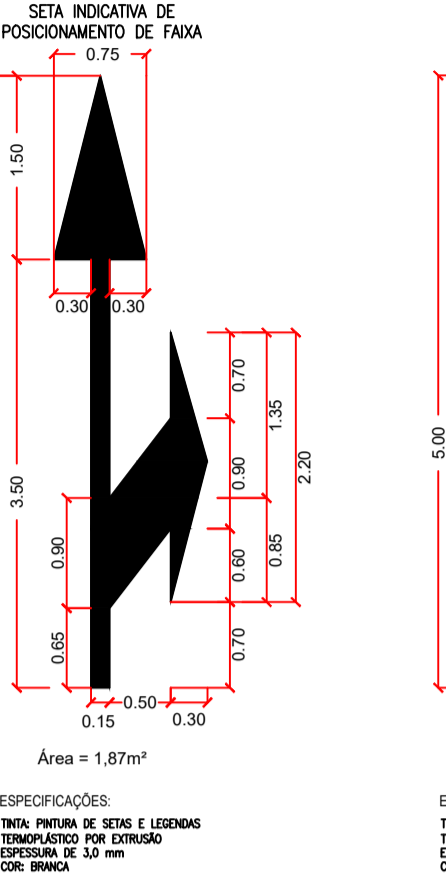
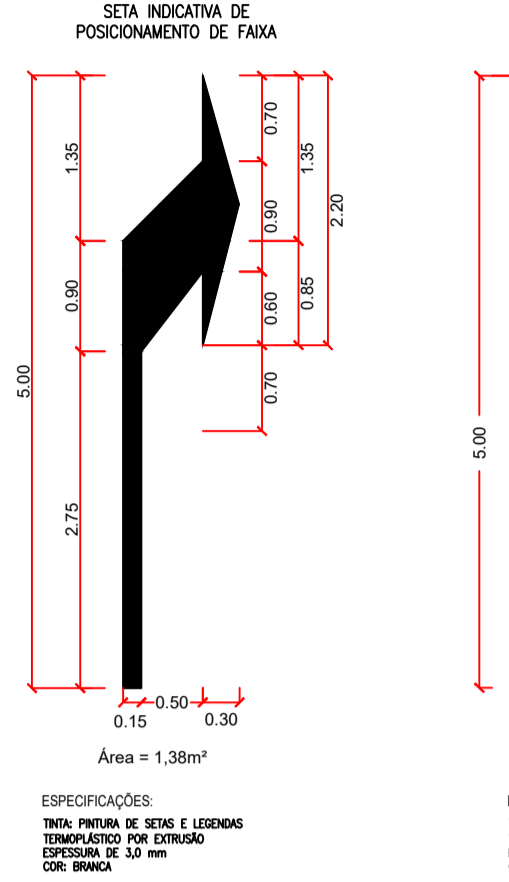
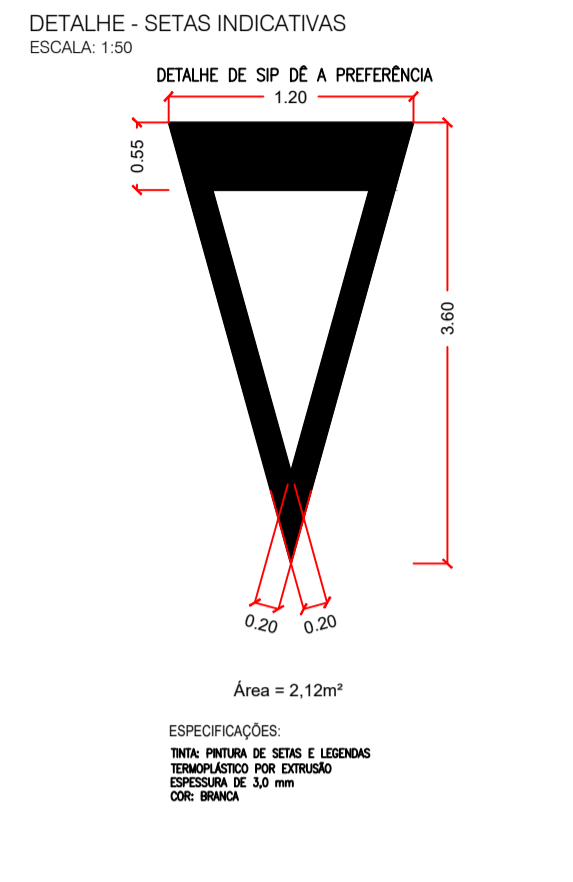
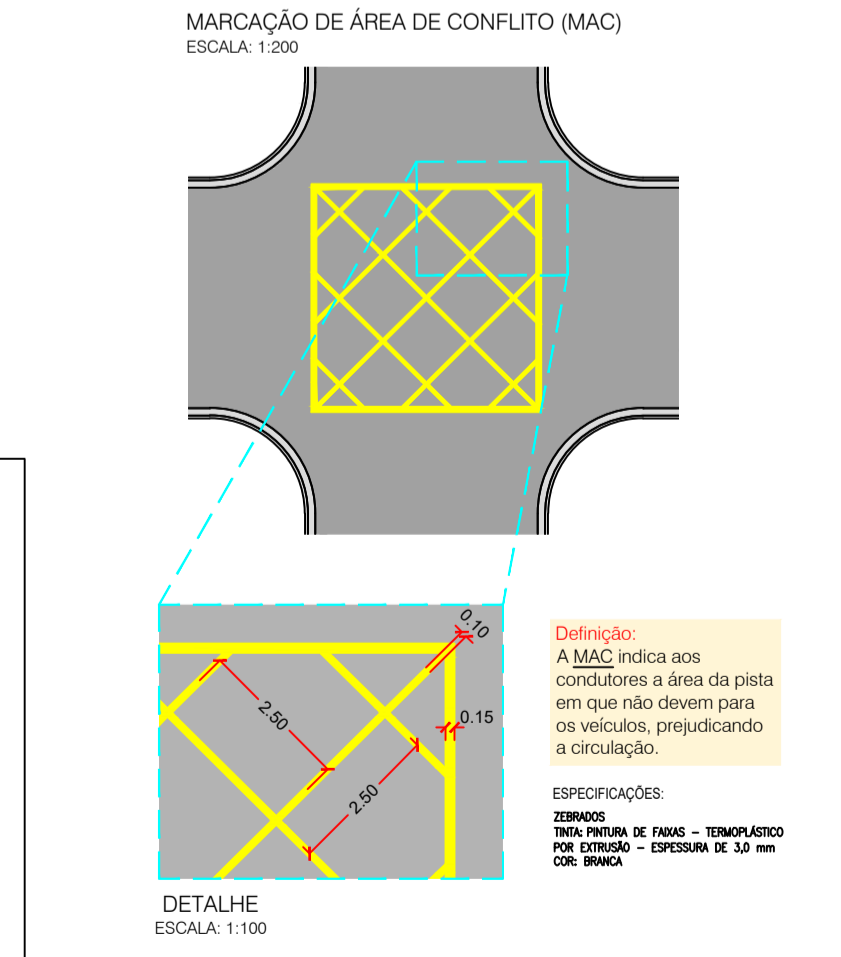
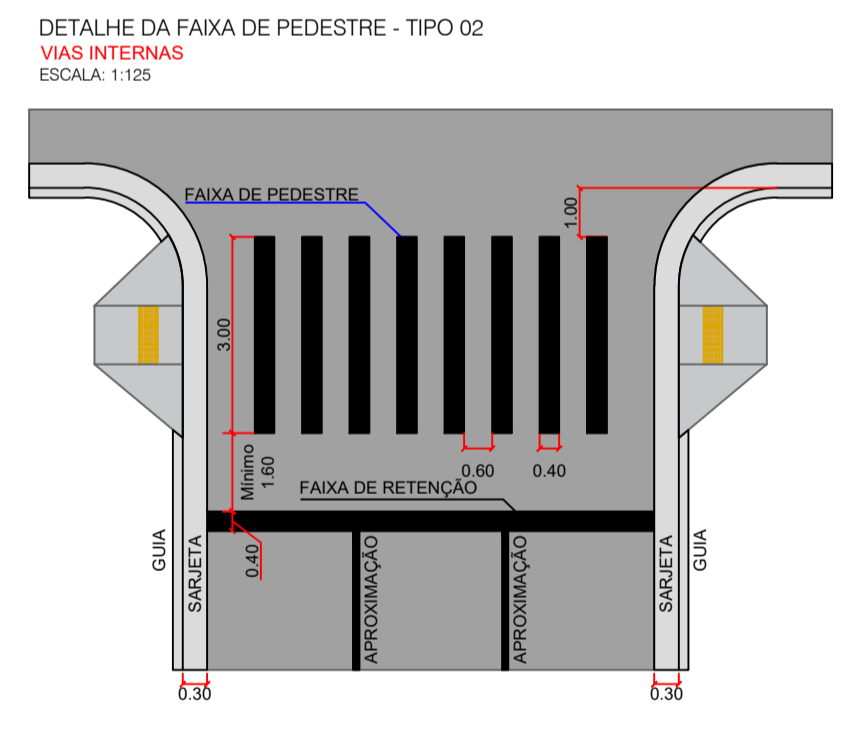
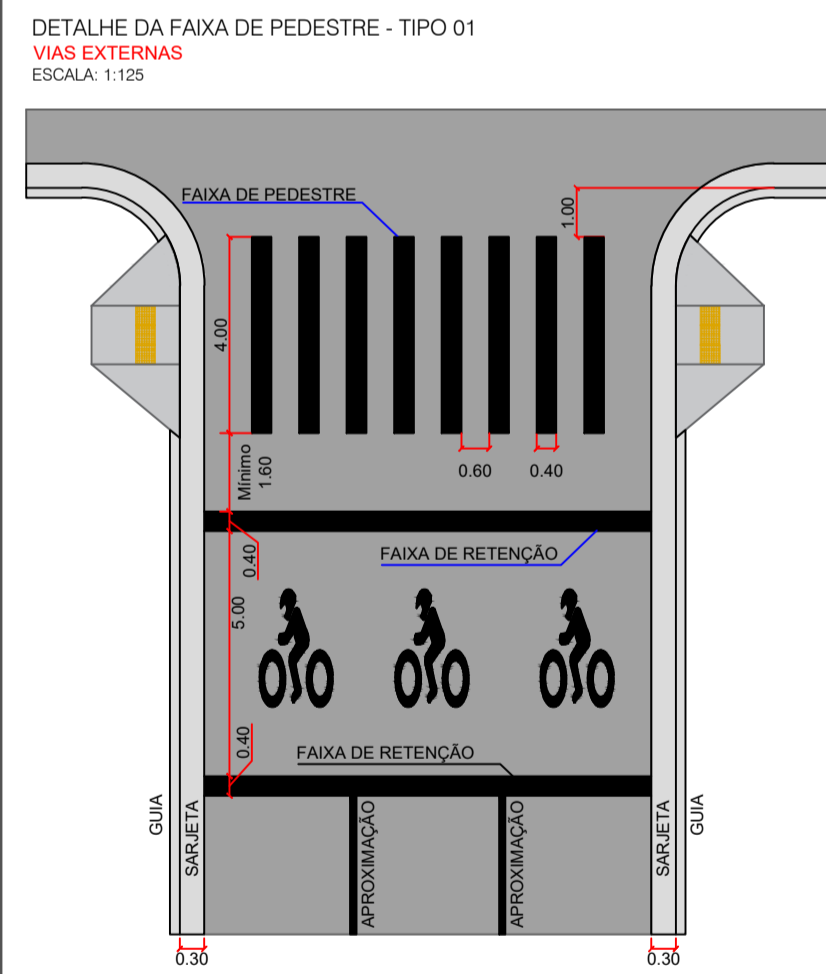
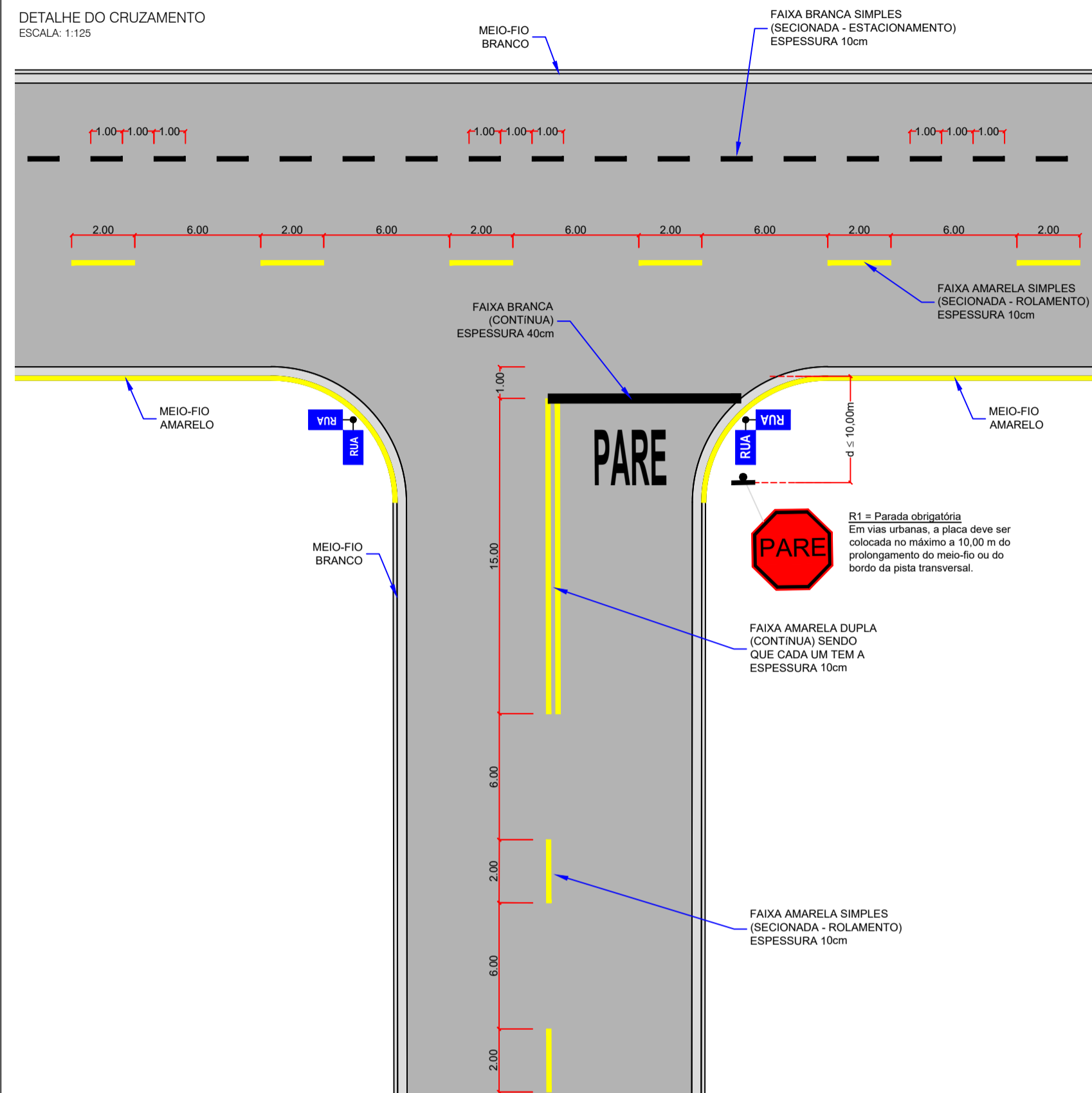

OBSERVAÇÕES

01 - ESTE DOCUMENTO É DE PROPRIEDADE DA PREFEITURA MUNICIPAL DE SIDROLÂNDIA/MS E NÃO PODE SER REPRODUZIDO OU USADO PARA QUALQUER FINALIDADE DIFERENTE DAQUELA PARA A QUAL ESTÁ SENDO FORNECIDO.

02 - DIRETOS AUTORIZADOS E PATRIMONIAIS RESERVADOS CONFORME LEI 9888, ARTIGO 6º, ALÍNEA X, DE 14/12/1973; LEI 5194, ARTIGO 17º E 18º, DE 24/07/1966; RESOLUÇÃO CONFEA Nº 598, DE 21/04/1979.

03 - O PROJETO DE SINALIZAÇÃO VÁRIA FOI ELABORADO DE ACORDO COM OS MANUAIS DE "SINALIZAÇÃO VERTICAL DE REGULAÇÃO" VOLUME I, CONTRANORMAS PUBLICADO POR MEIO DA RESOLUÇÃO Nº 186, DE 28 DE AGOSTO DE 2007, E DE "SINALIZAÇÃO HORIZONTAL" VOLUME IV, CONTRANORMAS PUBLICADO POR MEIO DA RESOLUÇÃO Nº 236, DE 11 DE MAIO DE 2007 E LEI Nº 9.503, DE SETEMBRO DE 1997, (CÓDIGO DE TRÁNSITO BRASILEIRO - CTB).

04 - ANTES DO INÍCIO DA EXECUÇÃO DA SINALIZAÇÃO, A FISCALIZAÇÃO DEVERÁ SUBMETTER, IMPRESCINDIVELMENTE, O PROJETO PARA APROVAÇÃO E APROVAÇÃO DO ÓRGÃO COMPETENTE.



PREFEITURA MUNICIPAL DE SIDROLÂNDIA/MS

OBJETO: INFRAESTRUTURA URBANA - RESTAURAÇÃO FUNCIONAL DO PAVIMENTO EM DIVERSAS RUAS NO MUNICÍPIO DE SIDROLÂNDIA/MS

LOCAL: DIVERSAS RUAS MUNICÍPIO DE SIDROLÂNDIA/MS

RESPONSÁVEL TÉCNICO PROJETO: FÁBIO MARQUES RIBEIRO (CREA Nº 15.276/MS)

PREFETO: VÂNDIA CRISTINA CAMILO (CPF: 03.081.874/MS-34)

TÍTULO: PROJETO EXECUTIVO PROJETO TIPO DE SINALIZAÇÃO HORIZONTAL

52/54

ESCALA: INDICADAS DATA: NOVEMBRO/2023 CONTRIBUTO: COORDENADOR: Nº

Nº DATA: APROVADO: DESENHOS DE REFERÊNCIA: NÚMEROS:

Arquivo: 023 Diversas Ruas - Projeto Tipo de Sinalização Horizontal.dwg